



Technical Data Sheet

Stowe High-Altitude Conversion Kit, NG

Assembly 93-56242

KIT CONTENTS:

- 1 - Main burner orifice, #42 (U.S.)
- 1 - NG pilot orifice, 0.62 mm
- 1 - Conversion label 3300-665
- 1 - Conversion label 3300-583
- 1 - Warning label 3300-587
- 1 - Installation manual

TOOLS REQUIRED:

- Flat-head screwdriver, 5/32"
- #2 Phillips screwdriver
- Hex wrench, 4 mm
- Socket wrench w/ 6" extension
- 1/2" Socket, 1" deep
- Manometer

WARNING

This conversion kit must be installed by a qualified service agency in accordance with the manufacturer's instructions and all applicable codes and requirements of the Authority Having Jurisdiction. If the information in these instructions is not followed exactly, a fire, explosion or production of carbon monoxide may result causing property damage, personal injury or loss of life. The qualified service agency is responsible for the proper installation of this kit. The installation is not proper and complete until the operation of the converted appliance is checked as specified in the manufacturer's instructions supplied with the kit.

This Natural Gas (NG) fuel conversion kit is for use with the Hearthstone Stowe 8324 only. This kit is suitable for installations at elevations between 2000 and 4500 feet above sea level. At elevations below 2000 feet, use NG Conversion Kit #93-56240.

Specification	NG	LP
INPUT RATING (Btu/hr) 0-2000 ft	22,400	22,400
INPUT RATING (Btu/hr) 2000-4500 ft	21,000	22,400
ORIFICE SIZE (DMS) 0-2000 ft	43	54
ORIFICE SIZE (DMS) 2000-4500 ft	42	54
MANIFOLD PRESSURE - LO SETTING (in.w.c./kPa)	1.2/0.30	4.2/1.05
MANIFOLD PRESSURE - HI SETTING (in.w.c./kPa)	3.6/0.90	10.1/2.52
INLET PRESSURE - MINIMUM (in.w.c./kPa)	5.0/1.24	11.0/2.74
MINIMUM INPUT RATING LO SETTING (Btu/hr)	15,000	15,000

Instructions

CAUTION: THE GAS SUPPLY SHALL BE SHUT OFF PRIOR TO DISCONNECTING THE ELECTRICAL POWER, BEFORE PROCEEDING WITH THE CONVERSION.

VALVE DESCRIPTION

- | | | |
|--|------------------------------|-----------------------------------|
| ① Gas cock knob | ⑥ Inlet pressure test point | ⑪ Flange securing screw holes |
| ② Manual HI-LO adjustment or pressure regulator adjustment | ⑦ Outlet pressure test point | ⑫ Additional valve mounting hole |
| ③ Pilot adjustment | ⑧ Main operator | ⑬ Alternative TC connection point |
| ④ Thermocouple connection | ⑨ Pilot outlet | ⑭ Thermoelectric unit |
| ⑤ Mounting for piezo & bracket | ⑩ Main gas outlet | |

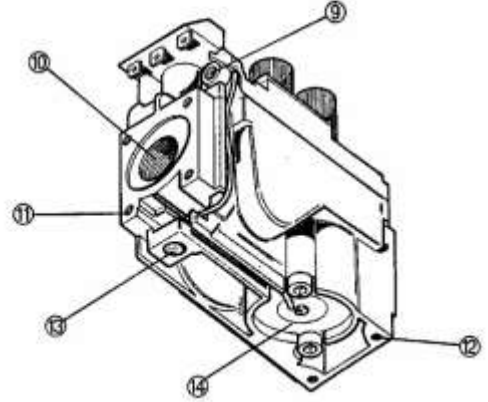
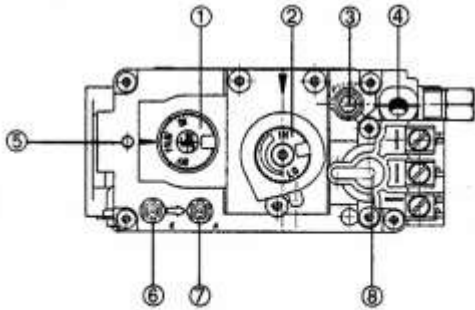

Figure 1 – SIT 820 Valve

NG conversion orifices are identified by size stamped on side of part. Ensure that orifice sizes are correct before installation.

*Note: **Do NOT** adjust any components marked with tamper-indicating paint.*



Figure 2 – Orifices, Marking Locations

To Convert the Valve to NG Operation:

1. Remove the stove front access panel to expose valve system.
2. Locate conversion plug at center of high/low adjustment knob. Pry off small black plastic cap.
3. Using 4 mm hex wrench, loosen and remove conversion plug.
4. Rotate conversion plug 180° and reinsert, tightening only until snug. Do not overtighten. Overtightening may result in permanent deformation of plug.
5. Snap plastic cap back into place.

Note: when installed in NG position, red ring will be on inward end of plug, and will not be visible.

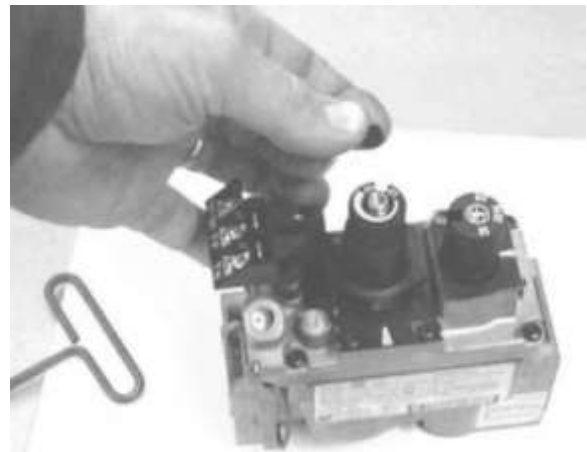

Figure 3 – Conversion Plug Location

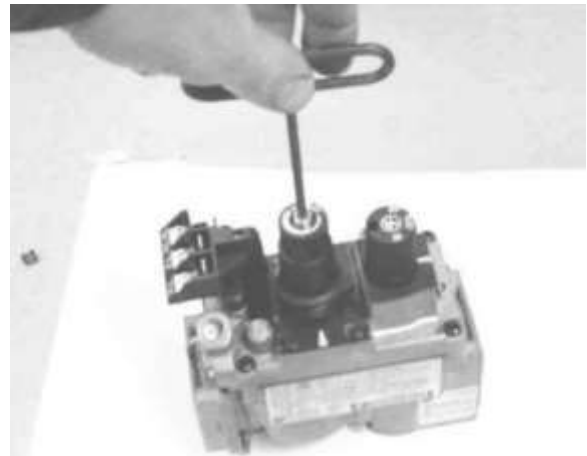

Figure 4 – Removing Conversion Plug



Figure 5 – Conversion Plug, Removed

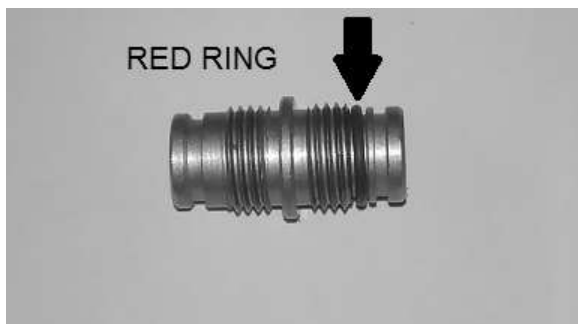

Figure 6 – Conversion Plug

To Switch Pilot to NG Operation:

To convert pilot from LP to NG:

1. Open firebox and remove logs, burner, and pilot shield. Refer to Stowe 8324 main product manual for guidance.
2. By hand or with tool, disengage wire clip and remove pilot burner hood.



Figure 7 – Removing Pilot Burner Hood

3. Using 4 mm hex wrench, loosen and remove LP pilot orifice. Replace with 0.62 mm NG pilot orifice and tighten until snug. Do not overtighten.



Figure 8 – Loosening Pilot Orifice



Figure 9 – Replacing Pilot Orifice

4. Reinstall pilot burner hood, ensuring that cutout on hood aligns with tang on stem of pilot. Engage wire clip, ensuring that clip holds burner hood in place.

To replace main burner orifice:

Locate the orifice mounting location at the rear of the firebox (see Figure 11). Using a 1/2" socket and extension, grasp orifice spud and turn counter-clockwise until loose. Remove and replace with #42 NG orifice spud, turning clockwise until snug.

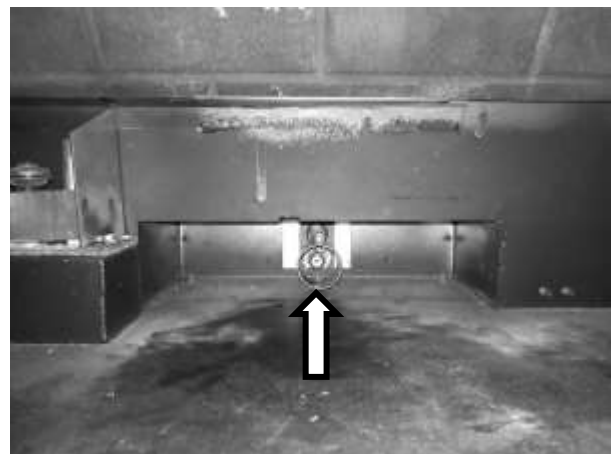

Figure 10 – Main Orifice Location

Reinstall burner, pilot shield, and logs. Ensure that pilot, pilot shield and burner are properly positioned before lighting appliance (see Figure 11). Reinstall front glass, and front and top cast.



Figure 11 – Pilot, Shield, and Burner Position

Checking for leaks:

To perform initial gas leak test:

1. Check carefully for gas leaks immediately after the conversion has been performed. **Do this before attempting to operate the appliance or other gas burning device.**
2. Use an approved non-corrosive leak detection fluid, or other approved leak detection method, around the diaphragm flanges, pipe connections, seal cap, and all other joints. Bubbles indicate a leak.
3. If no leakage is detected, proceed with the instructions listed below to light the main burner and perform a secondary leak check of the appliance gas supply system.
4. If a leak is detected, tighten pipe connections (including adapters) and retest.

To perform secondary leak test:

1. Light stove. With the main burner in operation, apply an approved leak test solution to all tubing, pipe connections, and adapters, and the valve inlet and outlet. Bubbles indicate a leak.
2. If no leak is detected, appliance is safe to use.
3. If a leak is detected, tighten pipe connections (including adapters) and retest.

WARNING

Absolutely no leakage should occur, otherwise there is a danger of fire or explosion depending upon conditions. Never use if leakage is detected.

Lighting instructions:

1. Set the on/off/T-stat switch or thermostat to the off position.
2. Unplug the blower accessory, if so equipped.
3. Push in and turn gas control knob clockwise to “OFF”. *(If not previously lit, the knob should be in this position.)*
4. Wait (5) five minutes to clear out any gas. If you then smell gas, STOP! *Smell all around the appliance area for gas. Be sure to smell next to the floor because some gases (LPG) are heavier than air and will settle on the floor. If you smell gas immediately, follow the **What To Do If You Smell Gas!** warning on the cover of the main Owner’s Manual. If you do not smell gas, go to the next step.*
5. Turn gas control knob counterclockwise to “PILOT”.
6. Push in control knob all the way and hold in. Immediately light the pilot with the gas lighter (push in and “click” the piezoelectric spark igniter button several times until lit). Continue to hold the control knob in for about 20 seconds after the pilot is lit. Release the knob and it will pop back out. Pilot should remain lit. If the pilot goes out, repeat the operation.
7. Turn gas control knob counterclockwise to “ON” position. Gas flow to main burner will begin when flame-sensing element is hot, and should ignite promptly.
8. To turn stove off, turn gas control knob clockwise to “OFF” position.

To verify input rate:

The approximate input rate of the converted Stowe may be checked as follows:

1. Ensure that no other gas appliances are in operation.
2. Place Stowe in operation on high, and allow to burn for 15 minutes.
3. Using residential gas meter, measure the time in seconds required for the Stowe to consume 1 cubic foot of gas.
4. The gas consumption of the Stowe in BTU per hour may be calculated as $(3,600 \times \text{heating value of gas}) \div \text{seconds to consume 1 cubic foot}$. Use local gas supplier’s heating value, or use 2,500 for LP or 1,012 for NG.

EXAMPLE: Using LP with a heating value of 2,500, and a time of 392 seconds (6 minutes 32 seconds):

$$(3,600 \times 2,500) \div 392 = 9,000,000 \div 392 = 22,959 \text{ BTU per hour}$$

Note: Stove may operate safely up to 105% of its rated input, or 25,520 BTU per hour. If Stove input is incorrect, it is necessary to adjust the gas supply pressure. Supply line/manifold gas line pressure adjustments must be performed by qualified service personnel. Do not attempt to complete any part of the installation or adjustment of this unit unless technically qualified to do so.

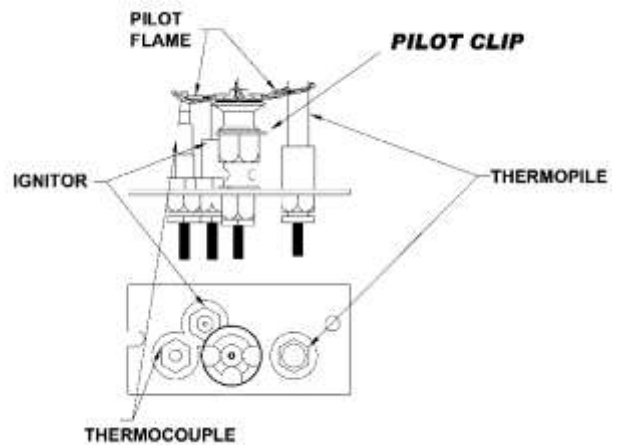

Figure 12: Pilot Assembly Detail

Checking gas pressures:

When installation is complete, verify that inlet and manifold pressures are correct. Pressure taps are located on the front of the valve (see Figure 1).

To check inlet pressure, with stove in operation, loosen threaded plug of inlet pressure tap and connect manometer. Retighten plug when finished.

To check manifold pressure, with stove in operation, loosen threaded plug of manifold pressure tap and connect manometer. Retighten plug when finished.

Manifold pressure adjustments:

CAUTION: THE VALVE MAXIMUM AND MINIMUM OUTLET PRESSURES ARE PRE-SET AT THE FACTORY AND CANNOT BE ADJUSTED. INPUT RATE IS ADJUSTABLE BY CHANGE OF ORIFICE SIZE ONLY, AND SHOULD ONLY BE ADJUSTED BY AN AUTHORIZED SERVICE TECHNICIAN.

Pilot adjustment:

The pilot light is preset by Hearthstone and should not need adjustment. The pilot light flame must be large enough to engulf the thermopile and thermocouple located next to the pilot, but not so large as to create excessive noise or consume excessive gas. However, it can be adjusted by means of the pilot light adjustment screw located on the gas control valve (see Figure 1).

Flame appearance:

Once the unit is lit, observe the flame pattern and adjust as necessary. To determine whether adjustment is necessary, flame pattern should be viewed with the valve output at its highest setting. Allow unit to operate for 10 minutes to allow flame pattern to stabilize before adjusting. Flame pattern should resemble that shown in Figure 13.



Figure 13 – Typical Flame Appearance

1. Flames should not be dirty, smoky, sooty, or lick the top of the stove.
2. Flames should not rise off the pan burner; this is called "lifting".
3. Flames should not impinge heavily on the log set. They should "fit" through the pre-formed spaces designed in the log set.

Flame appearance may be altered by adjusting air shutter.

1. If flame just above surface of burner or at base of logs is completely blue, air shutter may be open too far.
2. If flame is dirty, sooty, or licks at the top of the firebox, air shutter may be closed too far.

Air shutter is adjustable while the stove is burning. Loosen the lock nut on the adjusting bolt located in the lower rear center of the stove. Turn the bolt in to open the air shutter, and turn it out to close the shutter. When the flame pattern is correct, hold the adjusting bolt head still with a wrench and tighten the locking nut to the body of the stove.



Figure 14 – Air Shutter Adjustment

Conversion label placement:

When fuel conversion is complete, fill out and apply included marking labels to the appliance as shown.

Fill out all fields on large rating plate conversion label 3300-665 (number in lower right corner) and place over field provided on stove lighting instruction tag (see Figure 15).



Figure 15 – Rating Plate Conversion Label Location

Fill out all fields on smaller conversion label 3300-583 and place on upper surface of valve bracket (see Figure 16).



Figure 16 – Rating Plate Conversion Label Location

Place small valve warning label 3300-587 on or near valve body (see Figure 17).



Figure 17 – Valve Warning Label Location